

AP230022

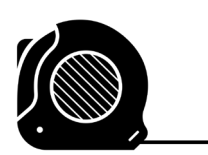

EN. Please read the information sheet before proceeding. FR. S'il vous plaît lire la fiche d'information avant de poursuivre. POL. Proszę przeczytać ulotkę informacyjną przed przejściem. DE. Bitte lesen Sie das Informationsblatt, bevor Sie fortfahren.

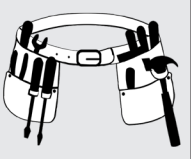
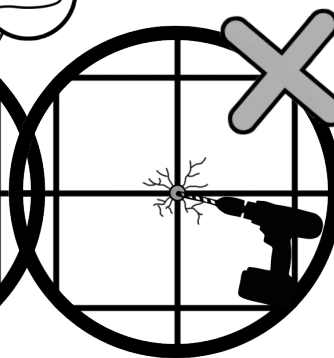
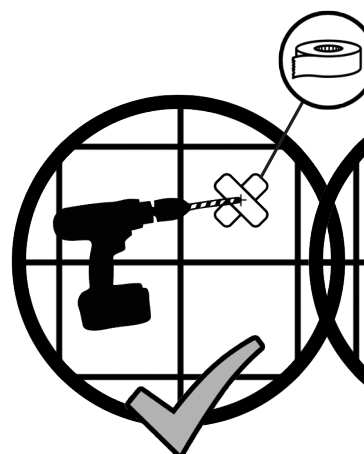
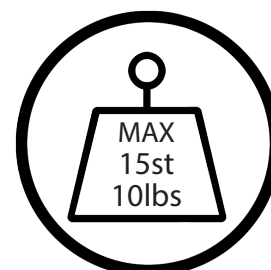
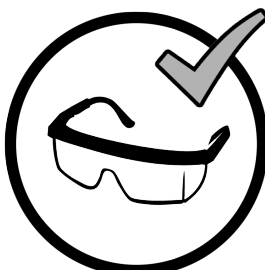

1.

S&H 063 R02

## Icon Library

## Wall Mounted Shower Seat



For reference only











Parts may vary.  
(Optional)



Warning! Please take special care.

Please read all of the information carefully and refer back when you see the numbered icons throughout instructions.

### Safety and Care

-  Always take care when using power tools, particularly if there is any water in the working area.
-  For different wall types you will need to ensure that you are using the correct type of fixing for the material of the wall. Wall fixings are not supplied with this product.
-  This product must only be fitted to solid brick, concrete block walls or similarly strong materials offering appropriate support for the maximum safe working load.
-  When drilling into a tiled surface do not use a hammer drill.
-  Always use a drill bit that is suitable for the surface that is being drilled.
-  To retain the best quality finish, clean product regularly with a soft damp cloth.
-  Do not use abrasive or chemical cleaners, as these will damage the product.
-  Dry the shower seat after use.
-  Check the shower seat is securely fastened to the wall before use.

## Bibliothèque d'icônes.

3.

## Siège de douche mural



À titre indicatif  
uniquement.











Les pièces peuvent  
varier.



Avertissement ! Faites  
très attention.

Veuillez lire attentivement toutes les informations et vous reporter à la signification des icônes numérotées lorsque vous les rencontrez au fil des instructions.

### Sécurité et prudence

-  Soyez toujours vigilants lorsque vous utilisez des outils électriques, notamment en présence d'eau dans l'espace de travail.
-  En présence de différents types de mur, vous devrez veiller à utiliser le bon type de fixation pour le matériau du mur. Les fixations murales ne sont pas fournies avec ce produit.
-  Ce produit doit être fixé uniquement à des murs en parpaing, en brique pleine ou autres matériaux robustes similaires offrant un support approprié pour la charge maximale d'utilisation.
-  N'utilisez jamais de marteau perforateur pour percer une surface carrelée.
-  Utilisez toujours une mèche adéquate pour la surface à percer.
-  Pour conserver une finition optimale, nettoyez régulièrement le produit avec un chiffon doux humide.
-  N'utilisez pas de nettoyants abrasifs ou chimiques car ils pourraient endommager le produit.
-  Séchez le siège de douche après utilisation.
-  Vérifiez que le siège de douche est solidement fixé au mur avant de l'utiliser.



 Croydex, Central Way, Andover,  
Hampshire, SP10 5AW, UK

 +44 (0) 1264 356437

 [www.croydex.com](http://www.croydex.com)

 +44 (0) 1264 365881

 [info@croydex.co.uk](mailto:info@croydex.co.uk)

S&H 063 R02

## Symbolverzeichnis. (DE)

## Wandmontierter Duschsitz (DE)



Nur als Referenz.



Teile können variieren.



Achtung! Bitte besonders vorsichtig sein.

Bitte lesen Sie sich alle Informationen sorgfältig durch und schlagen Sie nach, wenn Sie die nummerierten Symbole in der Anleitung sehen.

## Sicherheit und Pflege (DE)

- 1 Elektrowerkzeuge immer mit Sorgfalt verwenden, insbesondere dann, wenn Wasser im Arbeitsbereich vorhanden ist.
- 2 Bei verschiedenen Wandarten ist sicherzustellen, dass die richtige Art der Befestigung für das Wandmaterial verwendet wird. Wandbefestigungen werden nicht mit diesem Produkt mitgeliefert.
- 3 Dieses Produkt darf nur auf massiven Mauerwerk, Betonformsteinwänden oder ähnlich stabilen Materialien installiert werden, die ausreichenden Halt für die maximale sichere Gebrauchslast bieten.
- 4 Beim Bohren in eine Fliesenoberfläche keinen Bohrhammer verwenden.
- 5 Immer einen Bohraufsatz verwenden, der für die Bohroberfläche geeignet ist.
- 6 Produkt regelmäßig mit einem weichen, nebelfeuchten Tuch reinigen, um die hochwertige Oberflächenveredelung so gut wie möglich zu erhalten.
- 7 Keine abrasiven oder chemischen Reinigungsmittel verwenden, da diese das Produkt beschädigen können.
- 8 Nach dem Entfernen kann an einigen gestrichenen Oberflächen eine Renovierung erforderlich sein.
- 9 Duschsitz nach Gebrauch trocknen.

## Bibliothek ikon. (PL)

Montowane na ścianie siedzisko do kabiny prysznicowej (PL)



Tylko jako przykład.



Części mogą się różnić.



Ostrzeżenie! Zachować szczególną ostrożność.

**Przeczytać ze zrozumieniem wszystkie informacje i korzystać z nich w przypadku numerowanych ikon występujących w treści instrukcji.**

## Bezpieczeństwo i ochrona (PL)

- 1 Zawsze zachować ostrożność podczas korzystania z elektronarzędzi, w szczególności w przypadku ich użycia w obszarze pracy, w którym występuje woda.
- 2 Należy upewnić się w przypadku różnych typów ścian, czy posiadane elementy mocujące są przeznaczone do danego typu ściany. Elementy mocujące do ściany nie są dołączone do opakowania produktu.
- 3 Niniejszy produkt może być mocowany wyłącznie do ścian z litej cegły lub bloków betonowych lub podobnego wytrzymałego materiału zapewniającego odpowiednie wsparcie w celu zagwarantowania trwałości przy maksymalnym bezpiecznym obciążeniu roboczym.
- 4 Podczas wiercenia w powierzchnię z płytkami nie należy używać wiertarki udarowej.
- 5 Zawsze należy używać wiertła przeznaczonego do powierzchni, która ma zostać nawiercona.
- 6 W celu utrzymania najwyższej jakości produktu należy go regularnie czyścić przy użyciu miękkiej, wilgotnej szmatki.
- 7 Nie stosować chemicznych środków do czyszczenia o właściwościach ściernych, ponieważ mogą one prowadzić do uszkodzenia produktu.
- 8 Po użyciu zaleca się osuszenie siedziska kabiny prysznicowej.
- 9 Sprawdzić, czy siedzisko pod prysznic jest bezpiecznie przymocowane do ściany przed użyciem.



Croydex, Central Way, Andover,  
Hampshire, SP10 5AW, UK

+44 (0) 1264 356437

[www.croydex.com](http://www.croydex.com)

+44 (0) 1264 365881

[info@croydex.co.uk](mailto:info@croydex.co.uk)

S&H 063 R02

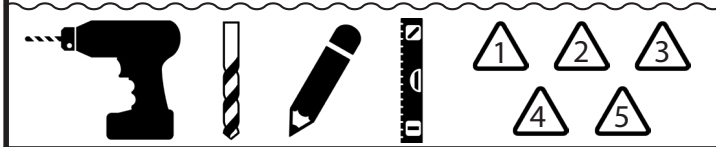
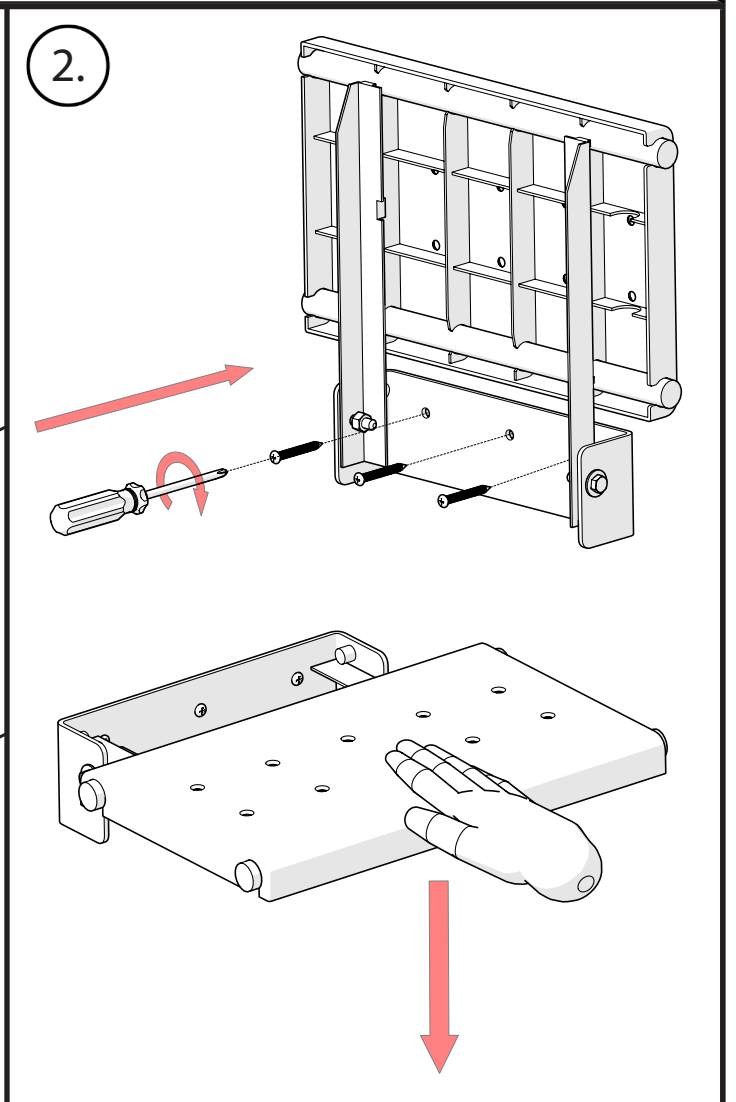
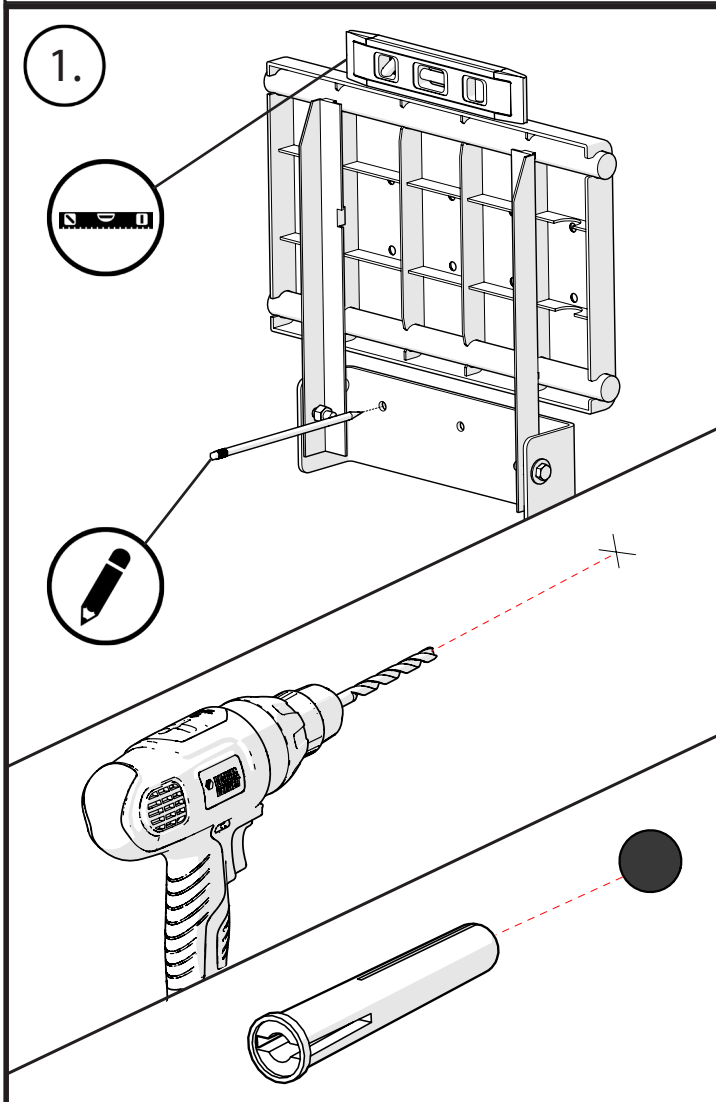
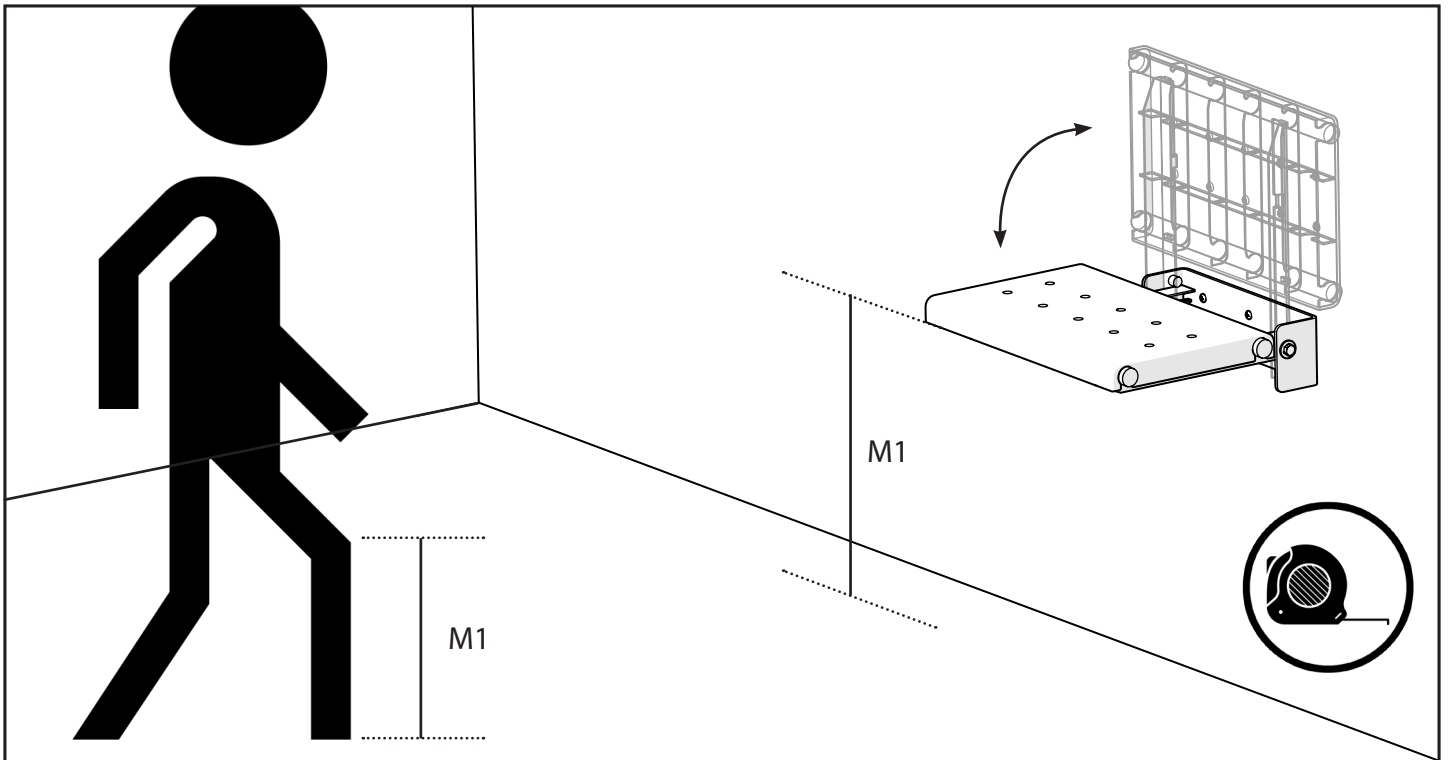

4.